

Fechamento hidráulico da porta

KALLAY

B2W

COMPRIMENTO 178 mm

LARGURA 260 mm

Força 2.

Peso da porta: 25 a 45 kg.

Largura máxima da porta.

Recomendado: 850 mm.

Sem retentor.

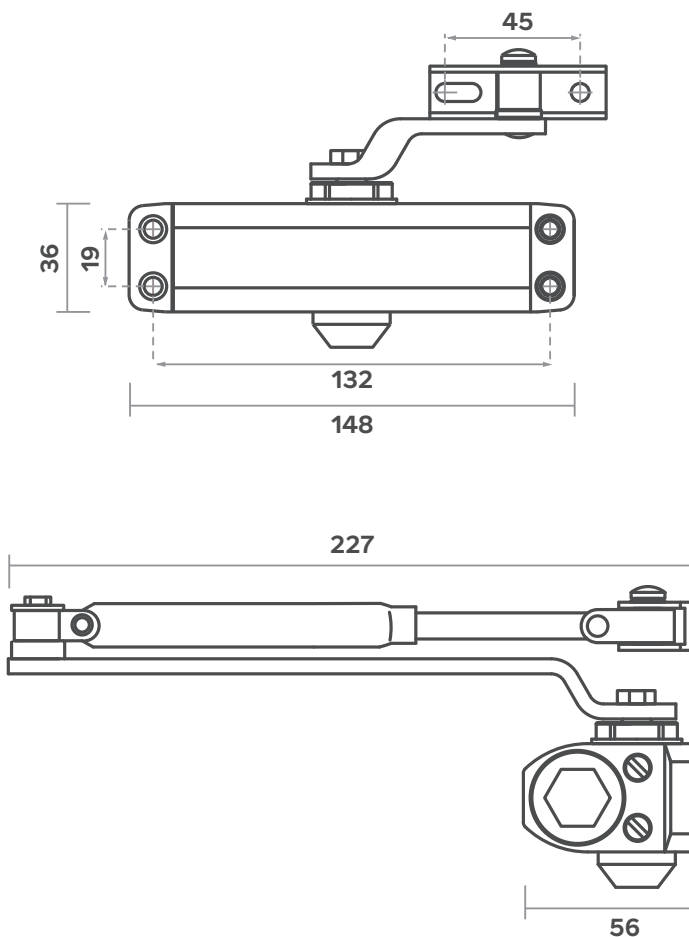

Força 2 | sem retentor